

Elastomer Materials	Temp. Range
Nitrile	-40°C to 120°C
Viton™/Fluorocarbon	-26°C to 204°C
EPDM	-54°C to 150°C
Chloroprene	-40°C to 121°C
Aflas® FEPM	-9°C to 232°C
Anti-Extrusion Material	
Acetal	-40°C to 100°C
Nylon	-30°C to 93°C

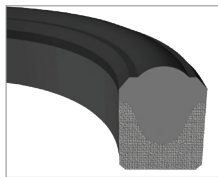

Single Acting  
Fabric Rod (F)

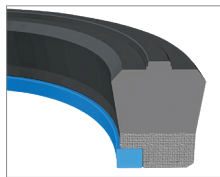

Single Acting  
Fabric Rod w/  
Anti-Extrusion (FE)



Double Acting (DAM)

## Product Description

Single acting fluid seals (SAM) can work both as a piston or rod seal. Our standard material is a nitrile sealing element with a fabric reinforced base. Corresponding wear rings are sold separately. Contact us for dimension information of single acting fluid seals with a anti-extrusion rings.

Our double acting fluid seals (DAM) are designed for use on split pistons. DAMs are composed of a nitrile sealing element, fabric reinforced base, and two acetal wear rings.

## Part Numbers:

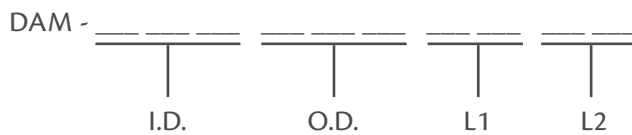
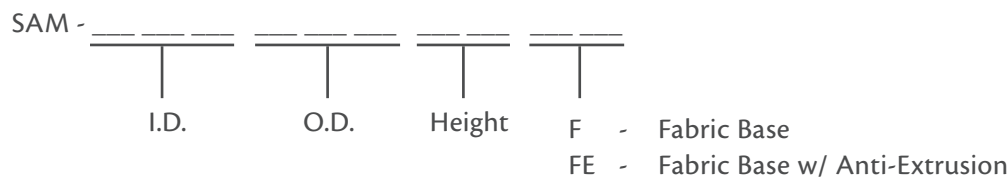

**Example:** SAM 70 90 14 FE - Single Acting Fluid Seal, Anti-Extrusion Ring, 70.00 mm I.D., 90.00 mm O.D., 14.00 mm Height

Single Acting

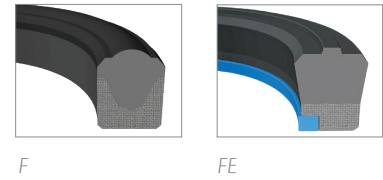
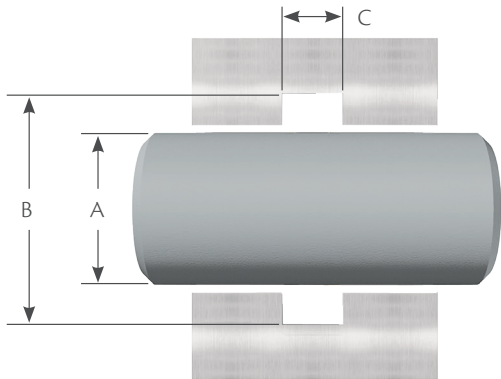

Part Number	A Shaft Diameter	B Groove Diameter	C Groove Width
SAM 5126 F	5.00	12.00	6.00
SAM 6136 F	6.00	13.00	6.00
SAM 8156 F	8.00	15.00	6.00
SAM 9166 F	9.00	16.00	6.00
SAM 10176 F	10.00	17.00	6.00
SAM 12196 F	12.00	19.00	6.00
SAM 14226 F	14.00	22.00	6.00
SAM 152363 F	15.00	23.00	6.30
SAM 152563 F	15.00	25.00	6.30
SAM 16246 F	16.00	24.00	6.00
SAM 18266 F	18.00	26.00	6.00
SAM 20286 FE	20.00	28.00	6.00
SAM 22306	22.00	30.00	6.00
SAM 223295	22.00	32.00	9.50
SAM 2232175 FE	22.00	32.00	17.50
SAM 24326	24.00	32.00	6.00
SAM 25336 FE	25.00	33.00	6.00
SAM 28366	28.00	36.00	6.00
SAM 283875 FE	28.00	38.00	7.50
SAM 30386	30.00	38.00	6.00
SAM 30458	30.00	45.00	8.00
SAM 32406	32.00	40.00	6.00
SAM 35436	35.00	43.00	6.00
SAM 35456 FE	35.00	45.00	6.00
SAM 354510 FE	35.00	45.00	10.00
SAM 355010 FE	35.00	50.00	10.00
SAM 36467 FE	36.00	46.00	7.00
SAM 36468 FE	36.00	46.00	8.00
SAM 364685	36.00	46.00	8.50
SAM 40486	40.00	48.00	6.00

Part Number	A Shaft Diameter	B Groove Diameter	C Groove Width
SAM 40488 F	40.00	48.00	8.00
SAM 40507 FE	40.00	50.00	7.00
SAM 405075 F	40.00	50.00	7.50
SAM 405010 FE	40.00	50.00	10.00
SAM 40529 FE	40.00	52.00	9.00
SAM 4052105 FE	40.00	52.00	10.50
SAM 405222 FE	40.00	52.00	22.00
SAM 40557 FE	40.00	55.00	7.00
SAM 406010 F	40.00	60.00	10.00
SAM 42506 F	42.00	50.00	6.00
SAM 45557 FE	45.00	55.00	7.00
SAM 455575 F	45.00	55.00	7.50
SAM 45558 F	45.00	55.00	8.00
SAM 455510 FE	45.00	55.00	10.00
SAM 456021 FE	45.00	60.00	21.00
SAM 50588 F	50.00	58.00	8.00
SAM 506058 FE	50.00	60.00	5.80
SAM 50607 FE	50.00	60.00	7.00
SAM 506075 F	50.00	60.00	7.50
SAM 506095 FE	50.00	60.00	9.50
SAM 50629 F	50.00	62.00	9.00
SAM 506556 F	50.00	65.50	6.00
SAM 506510 FE	50.00	65.00	10.00
SAM 506522 FE	50.00	65.00	22.00
SAM 556575 F	55.00	65.00	7.50
SAM 556510 FE	55.00	65.00	10.00
SAM 556512 F	55.00	65.00	12.00
SAM 5565175 FE	55.00	65.00	17.50
SAM 557514 FE	55.00	75.00	14.00
SAM 566675 F	56.00	66.00	7.50
SAM 5671105 FE	56.00	71.00	10.50
SAM 60707 FE	60.00	70.00	7.00

Fluid Seals

# Fluid Seals

METRIC SEALS

## Single Acting

Part Number	A Shaft Diameter	B Groove Diameter	C Groove Width
SAM 607075 F	60.00	70.00	7.50
SAM 607295 F	60.00	72.00	9.50
SAM 63759 F	63.00	75.00	9.00
SAM 638313 FE	63.00	83.00	13.00
SAM 65779 F	65.00	77.00	9.00
SAM 708012 FE	70.00	80.00	12.00
SAM 70829 F	70.00	82.00	9.00
SAM 708295 F	70.00	82.00	9.50
SAM 708210 FE	70.00	82.00	10.00
SAM 708412 FE	70.00	84.00	12.00
SAM 7085115 F	70.00	85.00	11.50
SAM 708512 FE	70.00	85.00	12.00
SAM 709013 FE	70.00	90.00	13.00
SAM 709014 FE	70.00	90.00	14.00
SAM 78868 F	78.00	86.00	8.00
SAM 80929 F	80.00	92.00	9.00
SAM 809295 F	80.00	92.00	9.50
SAM 809296 F	80.00	92.00	9.60
SAM 809512 FE	80.00	95.00	12.00
SAM 8010013 FE	80.00	100.00	13.00
SAM 8010015 FE	80.00	100.00	15.00
SAM 85979 F	85.00	97.00	9.00
SAM 85100125 F	85.00	100.00	12.50
SAM 8510510 F	85.00	105.00	10.00
SAM 901029 F	90.00	102.00	9.00
SAM 9010595 F	90.00	105.00	9.50
SAM 9010512 FE	90.00	105.00	12.00
SAM 90110114 FE	90.00	110.00	11.40
SAM 9011015 FE	90.00	110.00	15.00
SAM 95110113 F	95.00	110.00	11.30
SAM 9511513 FE	95.00	115.00	13.00
SAM 100115113 F	100.00	115.00	11.30
SAM 10512015 FE	105.00	120.00	15.00
SAM 110125113 F	110.00	125.00	11.30
SAM 115130113 F	115.00	130.00	11.30
SAM 12014012 FE	120.00	140.00	12.00
SAM 125140113 F	125.00	140.00	11.30
SAM 13014515 F	130.00	145.00	15.00
SAM 13515011 F	135.00	150.00	11.00
SAM 14016014 F	140.00	160.00	14.00

Part Number	A Shaft Diameter	B Groove Diameter	C Groove Width
SAM 14016016 F	140.00	160.00	16.00
SAM 14016028 F	140.00	160.00	28.00
SAM 15017015 F	150.00	170.00	15.00
SAM 16018015 F	160.00	180.00	15.00
SAM 170182710 F	170.00	182.70	10.00
SAM 18020015 F	180.00	200.00	15.00
SAM 20022015 F	200.00	220.00	15.00
SAM 20022016 F	200.00	220.00	16.00
SAM 20022535 F	200.00	225.00	35.00
SAM 21023016 F	210.00	230.00	16.00

Double Acting

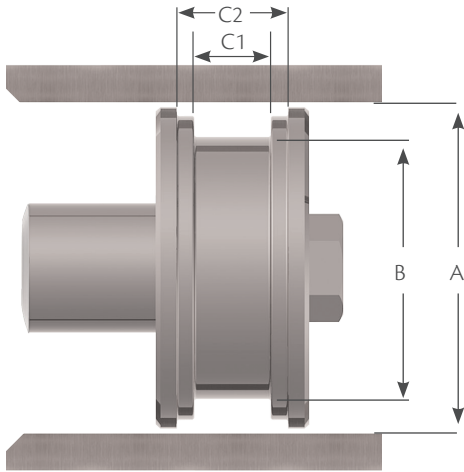

Fluid Seals

Part Number	A Bore Dia.	B Groove Dia.	C1 Groove Width	C2
DAM 15251220	25.00	15.00	12.00	20.00
DAM 2130135175	30.00	21.00	13.50	17.50
DAM 2232155207	32.00	22.00	15.50	20.70
DAM 22321628	32.00	22.00	16.00	28.00
DAM 24401830	40.00	24.00	18.00	30.00
DAM 2535155207	35.00	25.00	15.50	20.70
DAM 2535163291	35.00	25.00	16.30	29.10
DAM 26401520	40.00	26.00	15.00	20.00
DAM 29451831	45.00	29.00	18.00	31.00
DAM 30401220	40.00	30.00	12.00	20.00
DAM 304016428	40.00	30.00	16.40	28.00
DAM 31451521	45.00	31.00	15.00	21.00
DAM 32401521	40.00	32.00	15.00	21.00
DAM 34501831	50.00	34.00	18.00	31.00
DAM 34502026	50.00	34.00	20.00	26.00
DAM 38502028	50.00	38.00	20.00	28.00
DAM 39551830	55.00	39.00	18.00	30.00
DAM 39552126	55.00	39.00	21.00	26.00
DAM 40501119	50.00	40.00	11.00	19.00
DAM 4050125205	50.00	40.00	12.50	20.50
DAM 435520529	55.00	43.00	20.50	29.00
DAM 44601831	60.00	44.00	18.00	31.00
DAM 44602026	60.00	44.00	20.00	26.00
DAM 4555125205	55.00	45.00	12.50	20.50
DAM 47631830	63.00	47.00	18.00	30.00
DAM 47631932	63.00	47.00	19.00	32.00
DAM 47632026	63.00	47.00	20.00	26.00
DAM 48602028	60.00	48.00	20.00	28.00

Part Number	A Bore Dia.	B Groove Dia.	C1 Groove Width	C2
DAM 48632030	63.00	48.00	20.00	30.00
DAM 49652026	65.00	49.00	20.00	26.00
DAM 50651831	65.00	50.00	18.00	31.00
DAM 50702234	70.00	50.00	22.00	34.00
DAM 51632028	63.00	51.00	20.00	28.00
DAM 536312520	63.00	53.00	12.50	20.00
DAM 54702026	70.00	54.00	20.00	26.00
DAM 55702030	70.00	55.00	20.00	30.00
DAM 55752234	75.00	55.00	22.00	34.00
DAM 55753044	75.00	55.00	30.00	44.00
DAM 58702029	70.00	58.00	20.00	29.00
DAM 59752026	75.00	59.00	20.00	26.00
DAM 60802234	80.00	60.00	22.00	34.00
DAM 6080224352	80.00	60.00	22.40	35.20
DAM 60803145	80.00	60.00	31.00	45.00
DAM 62802229	80.00	62.00	22.00	29.00
DAM 637520528	75.00	63.00	20.50	28.00
DAM 65802028	80.00	65.00	20.00	28.00
DAM 65852234	85.00	65.00	22.00	34.00
DAM 66802233	80.00	66.00	22.00	33.00
DAM 70902234	90.00	70.00	22.00	34.00
DAM 72902229	90.00	72.00	22.00	29.00
DAM 75902030	90.00	75.00	20.00	30.00
DAM 75952236	95.00	75.00	22.00	36.00
DAM 751002234	100.00	75.00	22.00	34.00
DAM 76902232	90.00	76.00	22.00	32.00
DAM 801002240	100.00	80.00	22.00	40.00
DAM 801003554	100.00	80.00	35.00	54.00

# Fluid Seals

METRIC SEALS

## Double Acting

Part Number	A Bore Dia.	B Groove Dia.	C1 Groove Width	C2 Groove Width
DAM 801052235	105.00	80.00	22.00	35.00
DAM 821002230	100.00	82.00	22.00	30.00
DAM 851002030	100.00	85.00	20.00	30.00
DAM 851102235	110.00	85.00	22.00	35.00
DAM 861002232	100.00	86.00	22.00	32.00
DAM 901102537	110.00	90.00	25.00	37.00
DAM 901103554	110.00	90.00	35.00	54.00
DAM 901152235	115.00	90.00	22.00	35.00
DAM 921102230	110.00	92.00	22.00	30.00
DAM 951102030	110.00	95.00	20.00	30.00
DAM 951202235	120.00	95.00	22.00	35.00
DAM 961102232	110.00	96.00	22.00	32.00
DAM 971152229	115.00	97.00	22.00	29.00
DAM 1001202538	120.00	100.00	25.00	38.00
DAM 1001252538	125.00	100.00	25.00	38.00
DAM 1001253857	125.00	100.00	38.00	57.00
DAM 1031252636	125.00	103.00	26.00	36.00
DAM 10512525376	125.00	105.00	25.00	37.60
DAM 1051302537	130.00	105.00	25.00	37.00
DAM 1051302543	130.00	105.00	25.00	43.00
DAM 1081252640	125.00	108.00	26.00	40.00
DAM 1101352544	135.00	110.00	25.00	44.00
DAM 1151402537	140.00	115.00	25.00	37.00
DAM 1151402544	140.00	115.00	25.00	44.00
DAM 1181402536	140.00	118.00	25.00	36.00
DAM 1201452538	145.00	120.00	25.00	38.00
DAM 1251502544	150.00	125.00	25.00	44.00

Part Number	A Bore Dia.	B Groove Dia.	C1 Groove Width	C2 Groove Width
DAM 1281502536	150.00	128.00	26.50	37.00
DAM 1301602444	160.00	130.00	24.00	44.00
DAM 1301602538	160.00	130.00	25.00	38.00
DAM 1351602544	160.00	135.00	25.00	44.00
DAM 13516045704	160.00	135.00	45.00	70.40
DAM 1381602636	160.00	138.00	26.00	36.00
DAM 1401652544	165.00	140.00	25.00	44.00
DAM 1401702538	170.00	140.00	25.00	38.00
DAM 1431602040	160.00	143.00	20.00	40.00
DAM 143165265365	165.00	143.00	26.50	36.50
DAM 1451702550	170.00	145.00	25.00	50.00
DAM 1481702637	170.00	148.00	26.00	37.00
DAM 1501752550	175.00	150.00	25.00	50.00
DAM 1501803446	180.00	150.00	34.00	46.00
DAM 158180265367	180.00	158.00	26.50	36.70
DAM 1631802640	180.00	163.00	26.00	40.00
DAM 1651902550	190.00	165.00	25.00	50.00
DAM 1702003547	200.00	170.00	35.00	47.00
DAM 1752002550	200.00	175.00	25.00	50.00
DAM 1752003144	200.00	175.00	31.00	44.00
DAM 1902203447	220.00	190.00	34.00	47.00
DAM 1952202550	220.00	195.00	25.00	50.00
DAM 1952204570	220.00	195.00	45.00	70.00
DAM 200220315	220.00	200.00	31.50	49.90
DAM 2002253144	225.00	200.00	31.00	44.00
DAM 2152402550	240.00	215.00	25.00	50.00
DAM 2152404267	240.00	215.00	42.00	67.00
DAM 2302503048	250.00	230.00	30.00	48.00